

Bayesian Inference for Reliability of Systems and Networks using the Survival Signature

Louis J. M. Aslett¹, Frank P. A. Coolen² and Simon P. Wilson³

¹University of Oxford, ²Durham University, ³Trinity College Dublin

Abstract

The concept of survival signature has recently been introduced as an alternative to the signature for reliability quantification of systems. While these two concepts are closely related for systems consisting of a single type of component, the survival signature is also suitable for systems with multiple types of component, which is not the case for the signature. This also enables the use of the survival signature for reliability of networks. In this paper we present the use of the survival signature for reliability quantification of systems and networks from a Bayesian perspective. We assume that data are available on tested components which are exchangeable with those in the actual system or network of interest. These data consist of failure times and possibly right-censoring times. We present both a nonparametric and parametric approach.

Keywords: Bayesian methods; networks; nonparametrics; parametric lifetime distributions; system reliability.

1 Introduction

Quantification of reliability of systems and networks is of obvious importance in many application areas and has been the subject of a large literature. In recent years, the concept of system signature has become a popular tool to assist such quantification of reliability for systems consisting of components with random failure times that are independent and identically distributed (*iid*), although this can be relaxed to assuming exchangeability. We will refer to such components as components of a single type. A detailed introduction and overview to system signatures is presented by Samaniego⁽¹⁴⁾, some recent advances are reviewed by Eryilmaz⁽¹¹⁾. The signature of an m -component system is the vector with j -th component q_j the probability that the system fails at the j -th ordered failure time of its components, assuming that each component will fail only once after which it remains in a failed state. Generalisation of the signature to systems with multiple types of component would require computation of the probabilities of all

Note: This is the pre-peer reviewed version of the following article:

Aslett, L. J. M., Coolen, F. P. A and Wilson, S. P. (2015), 'Bayesian Inference for Reliability of Systems and Networks using the Survival Signature', *Risk Analysis* **35**(9), 1640–1651 which has been published in final form at <http://dx.doi.org/10.1111/risa.12228>.

possible different orderings of the order statistics of the different component lifetime distributions, which is very complex and not feasible for real-world systems⁽⁹⁾, although Boland, Samaniego and Vestrup⁽⁶⁾ show links between domination theory and signatures, allowing the former to be used for computational purposes and the latter for interpretation in the network reliability setting.

Recently, Coolen and Coolen-Maturi⁽⁹⁾ introduced the system survival signature as an alternative to the system signature. For systems consisting of a single type of component the survival signature is closely related to the signature. Crucially, the survival signature is also suitable for systems with multiple types of component, making it far more attractive for application to real world systems and networks. Consequently, lifetimes of components of different types are not *iid*, overcoming one of the long standing limitations of the signature. In this paper we present the use of the survival signature for reliability quantification of systems and networks from a Bayesian perspective. We assume that data are available on tested components of each type that occurs in the system, so on tested components which are not themselves in the system but are exchangeable with those of the same type in the actual system or network of interest. For ease of presentation, we restrict attention to test data consisting only of failure times, inclusion of right-censored observations being possible through standard statistical methods. We present both nonparametric and parametric Bayesian approaches, where particularly the former is straightforward to implement. For the parametric approach, we illustrate both the use of conjugate priors and models requiring advanced computational methods.

The related but reverse question of learning component reliability from system failure time data has been addressed in recent works using the signature for both a nonparametric⁽⁴⁾ and parametric^(2,13) setting. This setting is not considered in the current work for the survival signature, but presents an interesting avenue of future research.

Section 2 presents a brief introductory overview to the survival signature and its use for quantification of system reliability. The use of the survival signature for reliability assessment of networks is introduced in Section 3. Sections 4 and 5 present Bayesian nonparametric and parametric approaches to such reliability quantification, respectively, illustrated through examples. Section 6 concludes the paper with some remarks on related research challenges.

2 Survival signature

For a system consisting of m components with *iid* failure times (this assumption can be relaxed to exchangeable failure times), we define the state vector $\underline{x} = (x_1, x_2, \dots, x_m) \in \{0, 1\}^m$ with $x_i = 1$ if the i -th component functions and $x_i = 0$ if not. The labelling of the components is arbitrary but must be fixed to define \underline{x} . The structure function $\phi : \{0, 1\}^m \rightarrow \{0, 1\}$, defined for all possible \underline{x} , takes the value 1 if the system functions and 0 if the system does not function for state vector \underline{x} . Coolen and Coolen-Maturi⁽⁹⁾ defined the survival signature, denoted by $\Phi(l)$, for $l = 1, \dots, m$, as the probability that the system functions given that *precisely* l of its components function. For coherent systems, $\Phi(l)$ is an increasing function of l , and it is natural to assume that $\Phi(0) = 0$ and $\Phi(m) = 1$. There are $\binom{m}{l}$ state vectors \underline{x} with precisely l components $x_i = 1$, so with $\sum_{i=1}^m x_i = l$; let S_l denote the set of these state vectors. Due to the *iid* assumption for the failure times of the m components, all these state vectors are equally likely to occur

(this also holds under the weaker assumption of exchangeability), hence

$$\Phi(l) = \binom{m}{l}^{-1} \sum_{\underline{x} \in \mathcal{S}_l} \phi(\underline{x}) \quad (1)$$

Coolen and Coolen-Maturi⁽⁹⁾ called $\Phi(l)$ the survival signature because, by its definition, it is closely related to survival of the system, and it is close in nature to the system signature as will soon be clear.

Let $C_t \in \{0, 1, \dots, m\}$ denote the number of components in the system that function at time $t > 0$. Given the cumulative distribution function $F(t)$ for the failure times of the components, it is clear that, for $l \in \{0, 1, \dots, m\}$

$$P(C_t = l) = \binom{m}{l} [F(t)]^{m-l} [1 - F(t)]^l \quad (2)$$

This leads to

$$P(T_S > t) = \sum_{l=0}^m \Phi(l) P(C_t = l) \quad (3)$$

It is clear from Equation (3) that the term $\Phi(l)$ takes the structure of the system into account and is separated from the information about the failure time distribution for the components, which is included through the term $P(C_t = l)$. This means that the survival signature achieves the same separation of these two aspects as the signature does, which is the main advantage of the system signature⁽¹⁴⁾. This is not surprising, as the survival signature and the system signature are closely related. Indeed, it is easily seen that the following equality holds for coherent systems⁽⁹⁾

$$\Phi(l) = \sum_{j=m-l+1}^m q_j \quad (4)$$

Equation (4) is logical when considering that the right-hand side is the probability that the system failure time occurs at the moment of the $(m-l+1)$ -th ordered component failure time or later. This is exactly the moment at which the number of functioning components in the system decreases from l to $l-1$, hence the system would have functioned with l components functioning. Due to this direct relation between the survival signature and the system signature, for systems consisting of a single type of component with *iid* failure times, it is clear that the analytic possibilities provided by the signature are also provided by the survival signature^(9,14). For example, methods for comparison of two systems based on the survival signatures were presented by Coolen and Coolen-Maturi⁽⁹⁾. However, for systems with multiple types of components the survival signature remains straightforward and thus is far more attractive than the signature.

Consider a system with $K \geq 2$ types of components, with m_k components of type $k \in \{1, 2, \dots, K\}$ and $\sum_{k=1}^K m_k = m$. Assume that the random failure times of components of the same type are *iid*, while full independence is assumed for the random failure times of components of different types. Due to the arbitrary ordering of the components in the state vector, components of the same type can be grouped together, leading to a state vector that can be written as $\underline{x} = (\underline{x}^1, \underline{x}^2, \dots, \underline{x}^K)$, with $\underline{x}^k = (x_1^k, x_2^k, \dots, x_{m_k}^k)$ the sub-vector representing the states of the components of type k . Let the ordered random failure times of the m_k components of type k be denoted by $T_{j_k:m_k}^k$.

The survival signature for such a system is denoted by $\Phi(l_1, l_2, \dots, l_K)$, for $l_k = 0, 1, \dots, m_k$, which is defined to be the probability that a system functions given that *precisely* l_k of its m_k components of type k function, for each $k \in \{1, 2, \dots, K\}$ ⁽⁹⁾. There are $\binom{m_k}{l_k}$ state vectors \underline{x}^k with precisely l_k of its m_k components x_i^k equal to 1, so with $\sum_{i=1}^{m_k} x_i^k = l_k$; let S_l^k denote the set of these state vectors for components of type k . Furthermore, let S_{l_1, \dots, l_K} denote the set of all state vectors for the whole system for which $\sum_{i=1}^{m_k} x_i^k = l_k$, $k = 1, 2, \dots, K$. Due to the *iid* assumption for the failure times of the m_k components of type k , all the state vectors $\underline{x}^k \in S_l^k$ are equally likely to occur, hence

$$\Phi(l_1, \dots, l_K) = \left[\prod_{k=1}^K \binom{m_k}{l_k}^{-1} \right] \times \sum_{\underline{x} \in S_{l_1, \dots, l_K}} \phi(\underline{x}) \quad (5)$$

Let $C_t^k \in \{0, 1, \dots, m_k\}$ denote the number of components of type k in the system that function at time $t > 0$. If the probability distribution for the failure time of components of type k is known and has CDF $F_k(t)$, then for $l_k \in \{0, 1, \dots, m_k\}$, $k = 1, 2, \dots, K$,

$$\begin{aligned} P\left(\bigcap_{k=1, \dots, K} \{C_t^k = l_k\}\right) &= \prod_{k=1}^K P(C_t^k = l_k) \\ &= \prod_{k=1}^K \binom{m_k}{l_k} [F_k(t)]^{m_k - l_k} [1 - F_k(t)]^{l_k} \end{aligned} \quad (6)$$

The probability that the system functions at time $t > 0$ is

$$P(T_S > t) = \sum_{l_1=0}^{m_1} \cdots \sum_{l_K=0}^{m_K} \Phi(l_1, \dots, l_K) P\left(\bigcap_{k=1}^K \{C_t^k = l_k\}\right) \quad (7)$$

The survival signature $\Phi(l_1, \dots, l_K)$ must be derived for all $\prod_{k=1}^K (m_k + 1)$ different (l_1, \dots, l_K) . This information must anyhow be extracted from the system if one wishes to assess its reliability. The survival signature only has to be calculated once for any system, similar to the (survival) signature for systems with a single type of component. The main advantage of (7) is that again the information about system structure is fully separated from the information about the components' failure times, and the inclusion of the failure time distributions is straightforward due to the assumed independence of failure times of components of different types.

The survival signature $\Phi(l_1, \dots, l_K)$, as introduced for $K \geq 1$ different types of component, can be used as long as the failure times of components of the same type are exchangeable. In this paper we actually adopt the stronger assumption of *iid* failure times as this allows $P(C_t^k = l_k)$ to be written in terms of $F_k(t)$, as shown in Equation (6). Furthermore, we assumed that the failure times of components of different types are fully independent, which justifies the first equality in Equation (6). The main idea of the survival signature, however, can be applied without these assumptions, in which case the joint probability at the left-hand side of Equation (6) must be specified.

Computation of the survival signature is complicated for systems of realistic size. Aslett⁽³⁾ has presented a function in the statistical software R to compute the survival signature, which works well for systems of quite considerable size and is used in the examples in Sections 4 and 5. Recently, Coolen, Coolen-Maturi and Al-nefaiee⁽¹⁰⁾ presented

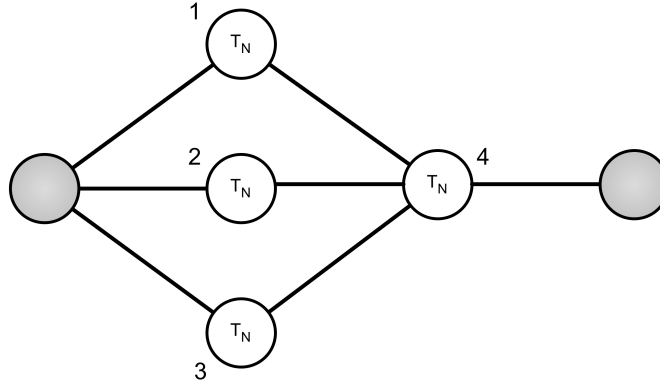

Figure 1: Topology of a simple network of 4 nodes and 7 links. Start and end nodes are shaded and assumed to function always.

some results that can be useful in particular situations, namely to combine survival signatures of subsystems in either series or parallel configuration and to adapt the survival signature in case of component replacement. Computation of the survival signature for large systems and networks presents interesting opportunities for further research.

3 Reliability of networks

Network reliability is an important application of system reliability. It is seeing an increase in interest as society is seen to be more vulnerable to failure of power supply and telecommunications networks⁽⁷⁾. A key property of such networks, that differs from what has been considered so far, is that both nodes and links are unreliable. This immediately presents problems for any analysis with the system signature because there are now at least 2 component types (links and nodes). Unless one is prepared to assume that links and nodes have the same failure probability or failure time distribution, so that there is still one component type, it cannot be used. However, this presents no problems to the survival signature.

We begin with a simple model of a network that consists of both links and nodes that may fail. For example, it may represent a telecommunications network where nodes are routers and links are cables, or a power network where nodes are transformers or other equipment to manage the supply and links are power lines. Figure 1 shows a simple network of 4 nodes and 7 links. This network can be transformed so that each link is represented by a node, so that the only unreliable parts of the system are nodes, as in Figure 2.

In the simplest case, all nodes are assumed independent or exchangeable, while all links are assumed independent or exchangeable. This leads to a system with two types of component and is the focus of this section. The survival signature can be evaluated in the usual way. The existence of different types of nodes and links can also be accommodated by adding to the number of component types.

In this simple case, assume that there are m_N nodes and m_L links in the network, and let $m = m_N + m_L$. The state vector is then $\underline{x} = (\underline{x}_N, \underline{x}_L) \in \{0, 1\}^m$, with $\underline{x}_N = (x_{N1}, \dots, x_{Nm_N})$ representing the state of the nodes and $\underline{x}_L = (x_{L1}, \dots, x_{Lm_L})$ representing the state of the links. The system state is $\phi(\underline{x})$. Following the development and notation of the previous section, we have the survival signature for l_N nodes and l_L links

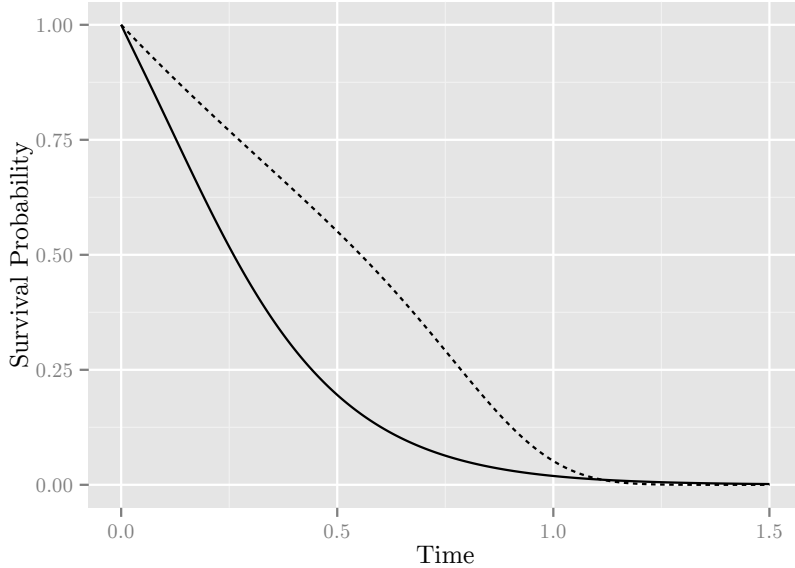

Figure 3: Two cases of the survival function for the network in Figure 1. In both cases, the link failure time is exponentially distributed with mean 1. The node failure time is exponentially distributed with mean 1 (solid line) and Weibull distributed with shape 5 and mean 1 (dashed line).

4 A nonparametric method

We consider the situation where test data are available on each type of component in a system or network which is used to infer reliability of the components. Using the survival signature, the uncertainty in the reliability of multiple components can be propagated to uncertainty in the lifetime of an entire system comprising those types of component. In this section this is done nonparametrically and will be demonstrated in a standard parametric setting in the sequel.

The survival signature makes it possible to tackle this problem for systems of a size which would be prohibitive were the structure function to be used directly. This is due to the natural separation of system structure and component lifetime which makes posterior predictive inference easy to generalise to arbitrary systems without resorting to extensive algebraic manipulation, as will be seen below.

At any fixed time t , the functioning of a single component of type k is Bernoulli(p_t^k) distributed for suitable p_t^k , irrespective of the lifetime distribution of the component. Correspondingly, the distribution of the number of components still functioning at time t in a collection of n_k *iid* components of type k is Binomial(n_k, p_t^k).

Let $S_t^k \in \{0, 1, \dots, n_k\}$ denote the number of functioning components in a test batch of n_k components of type k . Then, for each t , $S_t^k \sim \text{Binomial}(n_k, p_t^k)$ is a nonparametric model for the test batch (in the sense that it holds for any parametric lifetime distribution for the components), with p_t^k being the unknown parameter of interest.

A natural choice of prior distribution for such a model is $p_t^k \sim \text{Beta}(\alpha_t^k, \beta_t^k)$, since this results in a conjugate posterior distribution. One may choose $\alpha_t^k = \beta_t^k = 1 \forall t, k$ as a model of prior ‘ignorance’, or for example, if it is believed components are subject to wear or ‘bathtub curve’ characteristics then these can be a priori modelled with suitably varying α_t^k, β_t^k .

If testing of component k produces lifetime data $\underline{t}^k = \{t_1^k, \dots, t_{n_k}^k\}$, then at any fixed time t this results in an observation from the Binomial model of $s_t^k = \sum_{i=1}^{n_k} \mathbb{I}(t_i^k > t)$, where $\mathbb{I}(\cdot)$ is the indicator function. The conjugate Bayesian posterior for p_t^k is then:

$$p_t^k | s_t^k \sim \text{Beta}(\alpha_t^k + s_t^k, \beta_t^k + n_k - s_t^k)$$

The posterior predictive distribution for the number of components surviving at time t in a new batch of components is thus Beta-binomially distributed. That is, given a new batch of m_k components of type k , the distribution of the number of components surviving at time t , C_t^k , is:

$$C_t^k | s_t^k \sim \text{Beta-binomial}(m_k, \alpha_t^k + s_t^k, \beta_t^k + n_k - s_t^k)$$

Consequently, for a fixed t , the collection of minimal sufficient statistics from each test batch, $\{s_t^1, \dots, s_t^K\}$, can be used to produce a posterior predictive probability that a new system, S^* , comprising components of these types survives to time t . That is, the survival signature enables propagation of the uncertainty in survival of each component to an entire system based on component level test data:

$$\begin{aligned} & P(T_{S^*} > t | s_t^1, \dots, s_t^K) \\ &= \int \dots \int P(T_{S^*} > t | p_t^1, \dots, p_t^K) P(p_t^1 | s_t^1) \dots P(p_t^K | s_t^K) dp_t^1 \dots dp_t^K \\ &= \int \dots \int \left[\sum_{l_1=0}^{m_1} \dots \sum_{l_K=0}^{m_K} \Phi(l_1, \dots, l_K) P\left(\bigcap_{k=1}^K \{C_t^k = l_k | p_t^k\}\right) \right] \\ &\quad \times P(p_t^1 | s_t^1) \dots P(p_t^K | s_t^K) dp_t^1 \dots dp_t^K \\ &= \sum_{l_1=0}^{m_1} \dots \sum_{l_K=0}^{m_K} \Phi(l_1, \dots, l_K) \prod_{k=1}^K \int P(C_t^k = l_k | p_t^k) P(p_t^k | s_t^k) dp_t^k \end{aligned} \quad (9)$$

with the crucial simplification being that the posterior predictive distribution for each component is Beta-binomial:

$$\int P(C_t^k = l_k | p_t^k) P(p_t^k | s_t^k) dp_t^k = \binom{m_k}{l_k} \frac{B(l_k + \alpha_t^k + s_t^k, m_k - l_k + \beta_t^k + n_k - s_t^k)}{B(\alpha_t^k + s_t^k, \beta_t^k + n_k - s_t^k)} \quad (10)$$

Note in particular that this solution is easily implemented algorithmically because the survival signature has factorised the survival function by component type. In contrast, consider the structure function:

$$\phi(\underline{x}) = \prod_{j=1}^s \left(1 - \prod_{i \in C_j} (1 - x_i) \right)$$

where $\{C_1, \dots, C_s\}$ is the collection of minimal cut sets of the system⁽⁵⁾. Then,

$$P(T_{S^*} > t | s_t^1, \dots, s_t^K) = \int \dots \int \phi(p_t^{x_1}, \dots, p_t^{x_n}) P(p_t^1 | s_t^1) \dots P(p_t^K | s_t^K) dp_t^1 \dots dp_t^K$$

where $p_t^{x_i}$ is the element of $\{p_t^1, \dots, p_t^K\}$ corresponding to component i . This integral cannot easily be algorithmically solved because there is no simple factorisation of the different component types, leading to extensive (perhaps intractable) algebraic manipulation when system size and number of component types increases.

Finally, we note that if required a full posterior predictive distribution for the system lifetime can be built up by varying t to construct a survival curve.

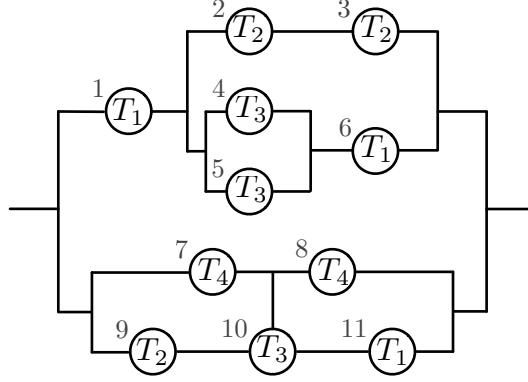

Figure 4: An 11 component system with 4 different types of component. Individual component labels are above to the left, whilst component type is inside the node.

4.1 Example

We illustrate this approach using the system layout given in Figure 4, with $K = 4$ types of component. The survival signature is detailed in Appendix A and took about 1.6 seconds to compute using the `computeSystemSurvivalSignature()` function in the ReliabilityTheory R package⁽³⁾. The lifetime, T_k , of component k was taken in each instance to be:

$$\begin{aligned} T_1 &\sim \text{Exponential}(\lambda = 0.55) \\ T_2 &\sim \text{Weibull}(\text{scale} = 1.8, \text{shape} = 2.2) \\ T_3 &\sim \text{Log-Normal}(\mu = 0.4, \sigma = 0.9) \\ T_4 &\sim \text{Gamma}(\text{scale} = 0.9, \text{shape} = 3.2) \end{aligned}$$

For simplicity, the prior parameters were taken to be $\alpha_t^k = \beta_t^k = 1 \forall t, k$, and 100 observations were simulated for each T_k to act as test batch data.

The resulting posterior predictive distribution for system survival can be seen in Figure 5, which is constructed by evaluating (9) and (10). This can be programmed with just a few lines of R code and evaluated at 300 values of t to produce the curve in approximately 2 seconds.

4.2 Further study

The ease that the survival signature provides for studying system reliability given component data leads to myriad additional possibilities for analysis. We consider one possible analysis of interest: given the option to add component redundancy, where should such redundancy be placed?

Figure 6 shows the posterior predictive survival curves when redundancy is added for each of the 11 components in turn. This being difficult to read, the bottom graph also shows the highest (top) to lowest (bottom) ordered survival probability as time progresses, with only none, component 7 and component 8 redundancy shown for clarity. No one component entirely dominates in survival function for the addition of redundancy, although as expected addition of any redundancy does uniformly dominate not adding redundancy.

For $t > 2$, addition of redundancy to component 7 uniformly dominates the other redundancy options, with redundancy on component 8 uniformly the second best choice.

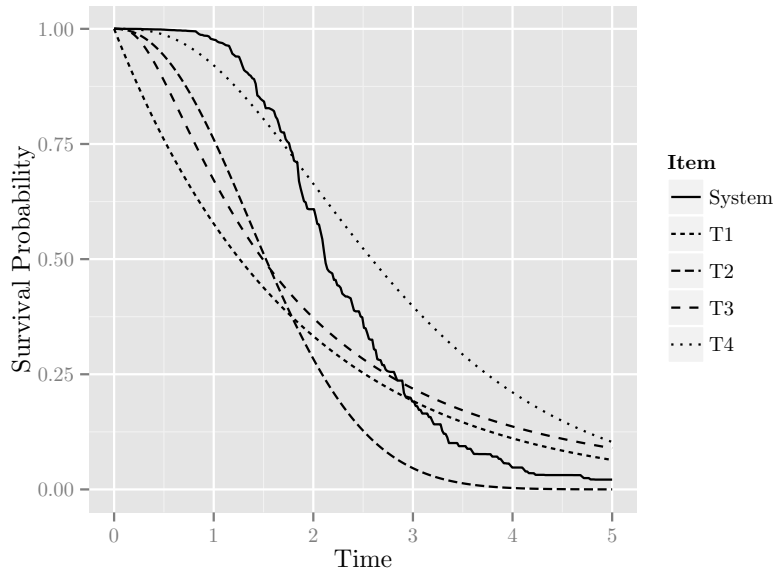

Figure 5: Posterior predictive survival function for the system along with (true) survival functions for the individual components.

It is an interesting result that these components are the best choices, both being of type T_4 , since this is the type with highest survival until $t = 5$. This highlights the importance of a full structural reliability analysis, since a naïve analysis may have assumed that any of the other 9 components of less reliable type may be preferable choices, the import of components 7 and 8 not being immediately obvious in a complex structure such as this.

Further avenues can readily be pursued. For example, since a full probability distribution may be derived from the survival function, it would be possible to use a decision theoretic framework which included component costing and negative utility for system unavailability in order to assess where redundancy would provide the highest expected utility for a given scenario.

5 Parametric component lifetime distributions

The nonparametric approach presented in Section 4 provides a very flexible modelling approach when the desire is to rely on minimal assumptions. However, in those instances where there is strong cause to believe a parametric model for the component lifetimes, or perhaps sufficient data to perform model diagnostics, then the exact same survival signature based framework accommodates completely flexible modelling.

There are two possible settings. First, in the spirit of the previous Section, the proposed likelihood model and prior for all components may have a closed form posterior distribution. Alternatively, given that specific likelihood models are being chosen for component lifetimes it may not be desirable, or in fact even possible, to specify either a conjugate prior or some prior leading to a tractably integrable posterior. Finally, a hybrid may be the case, where some of the components have closed form posterior distributions whilst others do not. All of these settings can be elegantly handled via the survival signature.

Let the likelihood model for component k be denoted $f_k(t; \psi_k)$ where the parameter(s)

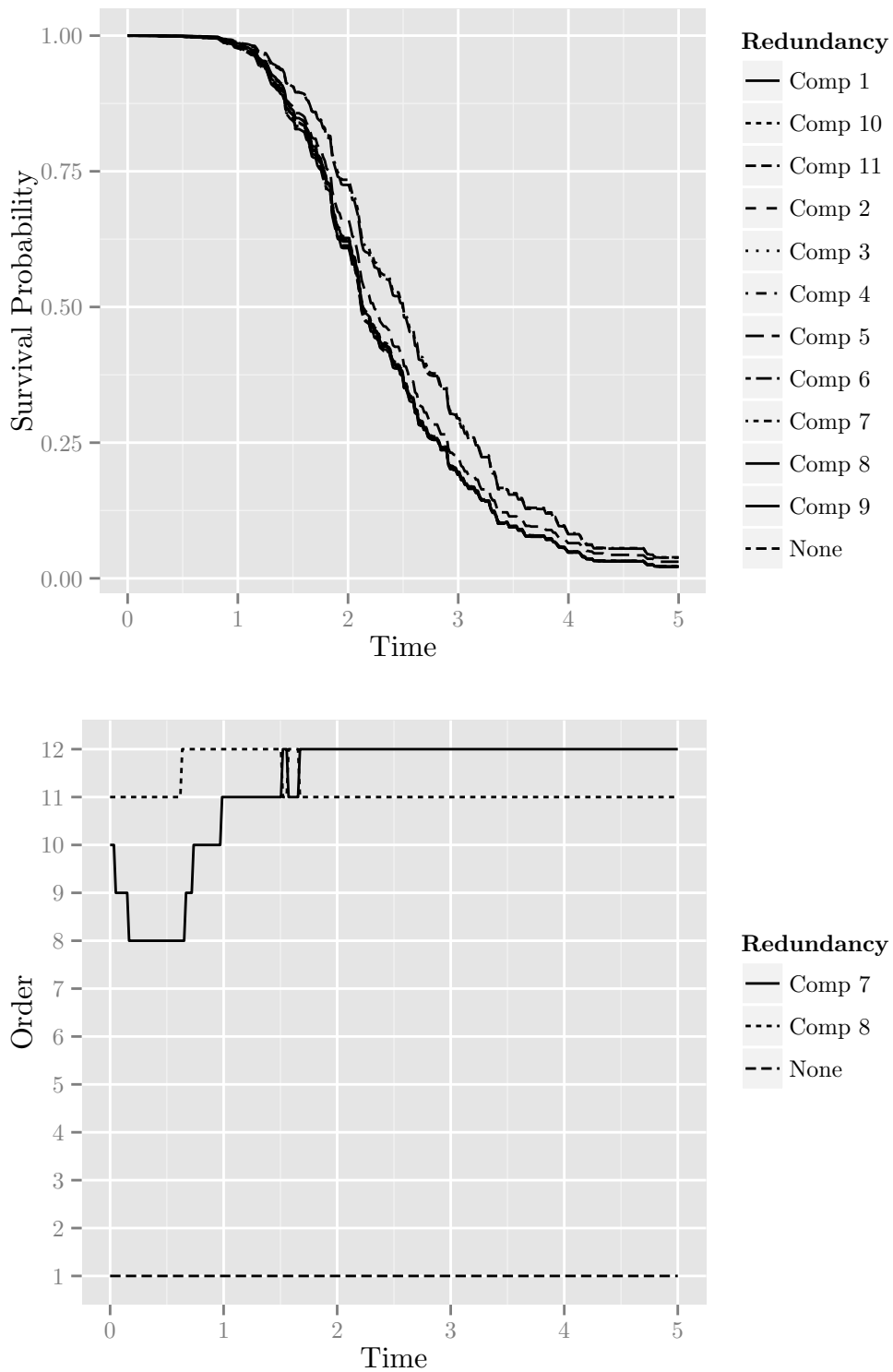

Figure 6: Top: Posterior predictive survival function with component redundancy added. Bottom: highest to lowest posterior survival probability over time.

of the model are ψ_k . Without loss of generality, ψ_k may be a vector of parameters. To complete the model in the Bayesian paradigm, we take the (joint) prior density for ψ_k to be $f_{\Psi_k}(\cdot)$.

As before, we consider testing of component k to produce lifetime data $\underline{t}^k = \{t_1^k, \dots, t_{n_k}^k\}$. This results in the standard Bayesian posterior density:

$$f_{\Psi_k | \underline{T}^k}(\psi_k | \underline{t}^k) \propto f_{\Psi_k}(\psi_k) \prod_{i=1}^{n_k} f_k(t_i^k; \psi_k)$$

Propagating this Bayesian posterior belief in component reliability to the system level then follows:

$$\begin{aligned} & P(T_{S^*} > t | \underline{t}^1, \dots, \underline{t}^K) \\ &= \int \cdots \int P(T_{S^*} > t | \psi_1, \dots, \psi_K) f_{\Psi_1 | \underline{T}^1}(d\psi_1 | \underline{t}^1) \cdots f_{\Psi_K | \underline{T}^K}(d\psi_K | \underline{t}^K) \\ &= \int \cdots \int \left[\sum_{l_1=0}^{m_1} \cdots \sum_{l_K=0}^{m_K} \Phi(l_1, \dots, l_K) P \left(\bigcap_{k=1}^K \{C_t^k = l_k | \psi_k\} \right) \right] \\ &\quad \times f_{\Psi_1 | \underline{T}^1}(d\psi_1 | \underline{t}^1) \cdots f_{\Psi_K | \underline{T}^K}(d\psi_K | \underline{t}^K) \\ &= \int \cdots \int \left[\sum_{l_1=0}^{m_1} \cdots \sum_{l_K=0}^{m_K} \Phi(l_1, \dots, l_K) \prod_{k=1}^K \binom{m_k}{l_k} [F_k(t; \psi_k)]^{m_k - l_k} [1 - F_k(t; \psi_k)]^{l_k} \right] \\ &\quad \times f_{\Psi_1 | \underline{T}^1}(d\psi_1 | \underline{t}^1) \cdots f_{\Psi_K | \underline{T}^K}(d\psi_K | \underline{t}^K) \\ &= \sum_{l_1=0}^{m_1} \cdots \sum_{l_K=0}^{m_K} \Phi(l_1, \dots, l_K) \prod_{k=1}^K \binom{m_k}{l_k} \int [F_k(t; \psi_k)]^{m_k - l_k} [1 - F_k(t; \psi_k)]^{l_k} f_{\Psi_k | \underline{T}^k}(d\psi_k | \underline{t}^k) \end{aligned}$$

The penultimate line following from (6). This mirrors part of the derivation in Section 4.

The only terms requiring further consideration are those which are posterior predictive of l_k components out of m_k of type k surviving to t :

$$\int [F_k(t; \psi_k)]^{m_k - l_k} [1 - F_k(t; \psi_k)]^{l_k} f_{\Psi_k | \underline{T}^k}(d\psi_k | \underline{t}^k) \quad (11)$$

There are three possibilities:

1. The posterior $f_{\Psi_k | \underline{T}^k}(d\psi_k | \underline{t}^k)$ is in closed form and the integral is tractable;
2. The posterior $f_{\Psi_k | \underline{T}^k}(d\psi_k | \underline{t}^k)$ is a known distribution, but the integral is intractable;
3. The posterior $f_{\Psi_k | \underline{T}^k}(d\psi_k | \underline{t}^k)$ is not in closed form.

However, noting that the integral is simply:

$$\mathbb{E}_{\Psi_k | \underline{T}^k} \left[[F_k(t; \psi_k)]^{m_k - l_k} [1 - F_k(t; \psi_k)]^{l_k} \right]$$

means that all three possibilities are easily handled, since Monte Carlo or Markov chain Monte Carlo can be used to evaluate the expectation with respect to the posterior.

In case 1, there is no problem. In case 2, samples can be drawn directly from the posterior, whilst in case 3 techniques such as importance sampling or Markov chain Monte

Carlo can draw samples from the posterior. Thus, for samples $\psi_k^{(1)}, \dots, \psi_k^{(N)} \sim \Psi_k | \underline{T}^k$, we invoke the standard result:

$$\begin{aligned} & \frac{1}{N} \sum_{i=1}^N [F_k(t; \psi_k^{(i)})]^{m_k - l_k} [1 - F_k(t; \psi_k^{(i)})]^{l_k} \\ & \xrightarrow{N \rightarrow \infty} \mathbb{E}_{\Psi_k | \underline{T}^k} [[F_k(t; \psi_k)]^{m_k - l_k} [1 - F_k(t; \psi_k)]^{l_k}] \end{aligned} \quad (12)$$

to evaluate the required integral. Note that the same samples may be used when computing for different values of t so that the computational burden is not too great.

Also, in particular a mix is possible: when closed forms are possible they lead to great efficiency for those components, and when not available standard numerical methods can be employed.

5.1 Example

We illustrate this approach by using the same system layout and component setup as in the previous Section in order to allow comparison of results between the methods. That is, the system is as depicted in Figure 4, with $K = 4$ types of component and the lifetime, T_k , of component k is taken in each instance to be:

$$\begin{aligned} T_1 & \sim \text{Exponential}(\lambda_1 = 0.55) \\ T_2 & \sim \text{Weibull}(\text{scale} = \lambda_2 = 1.8, \text{shape} = \gamma_1 = 2.2) \\ T_3 & \sim \text{Log-Normal}(\mu = 0.4, \tau = 1.234) \\ T_4 & \sim \text{Gamma}(\text{scale} = \lambda_3 = 0.9, \text{shape} = \gamma_2 = 3.2) \end{aligned}$$

In the parametric case, we take the following prior specifications:

$$\begin{aligned} \lambda_1, \tau & \sim \text{Gamma}(\text{rate} = 0.5, \text{shape} = 2) \\ \lambda_2, \lambda_3, \gamma_1, \gamma_2 & \sim \text{Uniform}(0, 10) \\ \mu & \sim \text{Normal}(\text{mean} = 2, \text{sd} = 10) \end{aligned}$$

These are relatively vague priors within the realm of what may be expected for component lives on the chosen scale.

5.1.1 Components of type 1

The choice of prior for λ_1 leads to a conjugate posterior, so that we may immediately write:

$$\Lambda_1 | \underline{t}^1 \sim \text{Gamma}(\text{rate} = 0.5 + n_1 \bar{t}^{-1}, \text{shape} = n_1 + 2)$$

Then, the required integral, (11), is:

$$\frac{(0.5 + n_1 \bar{t}^{-1})^{n_1 + 2}}{\Gamma(n_1 + 2)} \int_0^\infty [1 - e^{-\lambda_1 t}]^{3 - l_1} [e^{-\lambda_1 t}]^{l_1} \lambda_1^{1 + n_1} e^{-(0.5 + n_1 \bar{t}^{-1}) \lambda_1} d\lambda_1 \quad \text{for } l_1 \in \{0, 1, 2, 3\}$$

Following some routine calculus this results in the following for each l_1 :

$$\begin{aligned}
& (0.5 + n_1 \bar{t}^1)^{n_1+2} \left((0.5 + n_1 \bar{t}^1)^{-(n_1+2)} - 3(0.5 + t + n_1 \bar{t}^1)^{-(n_1+2)} \right. \\
& \quad \left. + 3(0.5 + 2t + n_1 \bar{t}^1)^{-(n_1+2)} - (0.5 + 3t + n_1 \bar{t}^1)^{-(n_1+2)} \right) \quad \text{for } l_1 = 0 \\
& (0.5 + n_1 \bar{t}^1)^{n_1+2} \left((0.5 + t + n_1 \bar{t}^1)^{-(n_1+2)} - 2(0.5 + 2t + n_1 \bar{t}^1)^{-(n_1+2)} \right. \\
& \quad \left. + (0.5 + 3t + n_1 \bar{t}^1)^{-(n_1+2)} \right) \quad \text{for } l_1 = 1 \\
& (0.5 + n_1 \bar{t}^1)^{n_1+2} \left((0.5 + 2t + n_1 \bar{t}^1)^{-(n_1+2)} - (0.5 + 3t + n_1 \bar{t}^1)^{-(n_1+2)} \right) \quad \text{for } l_1 = 2 \\
& \quad (0.5 + n_1 \bar{t}^1)^{n_1+2} (0.5 + 3t + n_1 \bar{t}^1)^{-(n_1+2)} \quad \text{for } l_1 = 3
\end{aligned}$$

Consequently, this posterior predictive term for components of type 1 is of the first type described, being tractable to compute algebraically. Hence, computation of the posterior predictive probabilities for collections of 3 such components is trivially easy and of negligible computational cost.

5.1.2 Components of type 2 and 4

For these components, there is no closed form for the posterior or posterior predictive distributions. Consequently, it is necessary to use a numerical method to evaluate the posterior predictive term required for the survival function of the system.

The standard random-walk Metropolis algorithm⁽¹⁵⁾ with multivariate Normal proposal was employed with covariance selected to result in acceptance rates of 20–30%. In this instance this required scaling the identity matrix by a factor of 0.2.

In the region of 10,000 samples proved sufficient to bring the MCMC standard error sufficiently low when estimated with batch means⁽¹²⁾. Alternatively, practitioners may simply choose a suitable thinning interval to result in 1,000 effectively independent samples. In either instance, only seconds of computation are required.

5.1.3 Components of type 3

The following two conjugacy results hold, where $\tau = 1/\sigma^2$ is the precision:

$$\begin{aligned}
\mu | \tau, \underline{t}^3 & \sim \text{Normal} \left(\text{mean} = \left[0.02 + \tau \sum \log t_i^3 \right] [0.01 + n_3 \tau]^{-1}, \text{precision} = 0.01 + n_3 \tau \right) \\
\tau | \mu, \underline{t}^3 & \sim \text{Gamma} \left(\text{rate} = \frac{1}{2} + \frac{1}{2} \sum (\log t_i^3 - \mu)^2, \text{shape} = 2 + \frac{n_3}{2} \right)
\end{aligned}$$

Consequently a standard Gibbs sampler can be employed and the resulting samples used in estimating the required expectation (12) as for the previous two component types.

5.1.4 Results

The full analysis runs in a little over 3 minutes on a 7 year old Intel Core 2 Duo laptop. Figure 7 shows the posterior densities as estimated in 5.1.1–5.1.3. Interestingly, the component test data resulted in poor posterior accuracy for λ_2 and γ_1 , although not in a way that substantially affects the expected component lifetime substantially. The effect is to reduce the tail weight in the Weibull compared to the ground truth which generated the type 2 components test data. The other posterior densities are reasonable.

The resulting posterior predictive distribution for system survival as propagated by the system signature can be seen in Figure 8 alongside the non-parametric case and ground

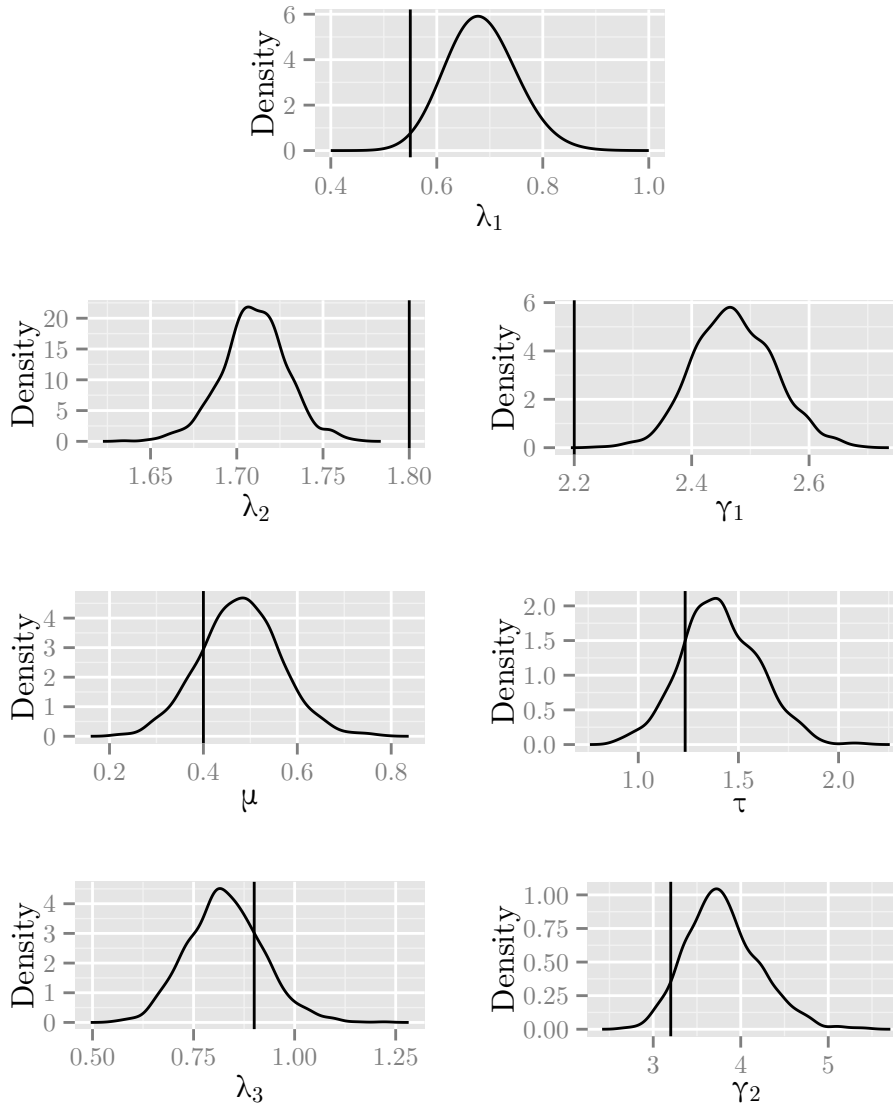

Figure 7: Posterior densities for each parameter. Vertical lines indicate the ground truth in the model.

truth. The ground truth is computed by using the known component lifetime distribution for $F_k(\cdot)$ in (6) and (7). This shows that both parametric and non-parametric system survival curve estimates are very close to the true system survival.

6 Concluding remarks

The survival signature has been shown to provide a practical method of propagating the full knowledge and uncertainty about reliability of several types of component to the system level in both non-parametric and parametric Bayesian settings. In particular, the survival signature avoids potentially intractable algebra associated with use of the structure function directly and so is an algorithmically straightforward approach to implement.

It has also been shown that reliability of networks, whereby not only nodes but also

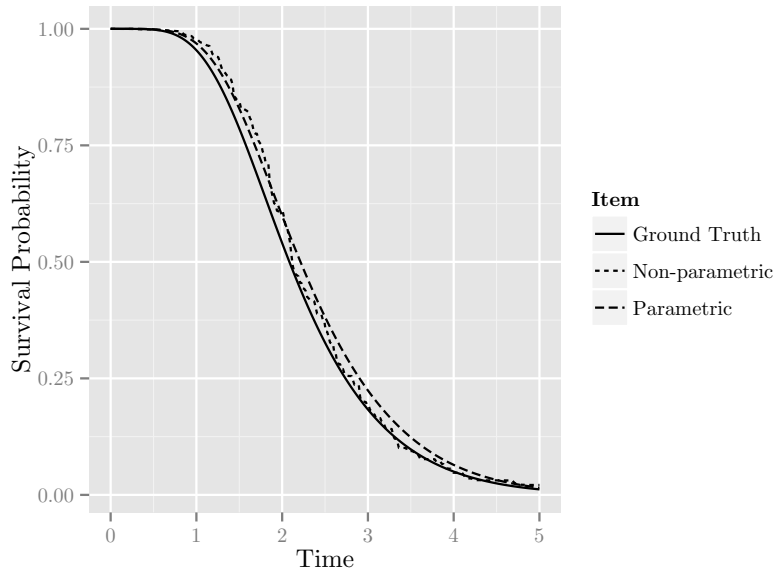

Figure 8: Posterior predictive survival function for the system in both parametric and non-parametric cases.

links are unreliable, can be easily handled by the survival signature. This enables treatment of point-to-point reliability of telecommunications, power and other networks in a realistic fashion with links not restricted to being modelled with similar failure characteristics to nodes.

A demonstration was also provided of how this approach opens the possibility of answering important questions about system reliability, such as optimal component redundancy, whilst fully accounting for system structure. This provides an interesting new technique for future research into an array of system-level questions which have hitherto been challenging to answer for systems of non-trivial size.

In practical application the approach shown herein should be appealing, because the nonparametric option can be used with minimal assumptions. Additionally, the survival signature is easily computed using the freely available ReliabilityTheory R package⁽³⁾ and the overall computation times involved even for fairly large systems is small and so entirely feasible. Indeed, even in the parametric case, the separation of system structure and component reliability enables the extensive computational tools available for statistical inference on component level data (such as MCMC) to dovetail naturally with quantification of the uncertainty in system lifetime.

In principle both of these approaches can be fully automatically programmed enabling reliability practitioners to utilise the theory without extensive effort, something which would not have been possible with the structure function (due to extensive and possibly intractable algebraic manipulation), or with the signature (due to the constraint that components must be of the same type). This is something we aim to provide as part of future research work.

Acknowledgments

Louis Aslett and Simon Wilson were funded partly by the STATICA project (SFI grant number 08/IN.1/I1879). Louis Aslett was also funded partly by the i-like project (EPSRC grant reference number EP/K014463/1).

A Survival signature

The following is the survival signature of the system in Figure 4. All entries with survival signature equal to either 0 or 1 have been suppressed, these values will be clear from the monotonicity of the survival signature and the values given in the table.

C1	C2	C3	C4	$\mathbb{P}(\cdot)$	C1	C2	C3	C4	$\mathbb{P}(\cdot)$	C1	C2	C3	C4	$\mathbb{P}(\cdot)$	C1	C2	C3	C4	$\mathbb{P}(\cdot)$
0	1	1	1	$\frac{1}{18}$	1	1	3	1	$\frac{1}{3}$	2	0	1	0	$\frac{2}{9}$	2	2	2	1	$\frac{7}{9}$
0	1	2	1	$\frac{1}{9}$	1	2	0	0	$\frac{1}{9}$	2	0	1	1	$\frac{1}{3}$	2	2	3	0	$\frac{8}{9}$
0	1	3	1	$\frac{1}{6}$	1	2	0	1	$\frac{1}{9}$	2	0	2	0	$\frac{1}{3}$	2	2	3	1	$\frac{17}{18}$
0	2	1	1	$\frac{1}{9}$	1	2	1	0	$\frac{5}{27}$	2	0	2	1	$\frac{5}{9}$	2	3	0	0	$\frac{2}{3}$
0	2	2	1	$\frac{2}{9}$	1	2	1	1	$\frac{5}{18}$	2	0	3	0	$\frac{1}{3}$	2	3	0	1	$\frac{2}{3}$
0	2	3	1	$\frac{1}{3}$	1	2	2	0	$\frac{7}{27}$	2	0	3	1	$\frac{2}{3}$	2	3	1	0	$\frac{7}{9}$
0	3	1	1	$\frac{1}{6}$	1	2	2	1	$\frac{4}{9}$	2	1	1	0	$\frac{8}{27}$	2	3	1	1	$\frac{7}{9}$
0	3	2	1	$\frac{1}{3}$	1	2	3	0	$\frac{1}{3}$	2	1	1	1	$\frac{7}{18}$	2	3	2	0	$\frac{8}{9}$
0	3	3	1	$\frac{1}{2}$	1	2	3	1	$\frac{11}{18}$	2	1	2	0	$\frac{13}{27}$	2	3	2	1	$\frac{8}{9}$
1	0	1	1	$\frac{1}{18}$	1	3	0	0	$\frac{1}{3}$	2	1	2	1	$\frac{17}{27}$	3	0	1	0	$\frac{2}{3}$
1	0	2	1	$\frac{1}{9}$	1	3	0	1	$\frac{1}{3}$	2	1	3	0	$\frac{5}{9}$	3	0	1	1	$\frac{5}{6}$
1	0	3	1	$\frac{1}{6}$	1	3	1	0	$\frac{4}{9}$	2	1	3	1	$\frac{7}{9}$	3	1	1	0	$\frac{7}{9}$
1	1	1	0	$\frac{1}{27}$	1	3	1	1	$\frac{1}{2}$	2	2	0	0	$\frac{2}{9}$	3	1	1	1	$\frac{8}{9}$
1	1	1	1	$\frac{1}{9}$	1	3	2	0	$\frac{5}{9}$	2	2	0	1	$\frac{2}{9}$	3	2	0	0	$\frac{1}{3}$
1	1	2	0	$\frac{2}{27}$	1	3	2	1	$\frac{2}{3}$	2	2	1	0	$\frac{14}{27}$	3	2	0	1	$\frac{1}{3}$
1	1	2	1	$\frac{2}{9}$	1	3	3	0	$\frac{2}{3}$	2	2	1	1	$\frac{31}{54}$					
1	1	3	0	$\frac{1}{9}$	1	3	3	1	$\frac{5}{6}$	2	2	2	0	$\frac{20}{27}$					

References

1. Al-nefaiee A.H. and Coolen F.P.A. Nonparametric predictive inference for system failure time based on bounds for the signature. *Proceedings of the Institution of Mechanical Engineers, Part O: Journal of Risk and Reliability*, **227** 513–522 (2013).
2. Aslett L.J.M. *MCMC for Inference on Phase-type and Masked System Lifetime Models*. PhD Thesis, Trinity College Dublin (www.louisaslett.com) (2012).
3. Aslett L.J.M. *ReliabilityTheory: Tools for structural reliability analysis*. R package (2012).
4. Balakrishnan, N., Ng, H.K.T. and Navarro J. Exact nonparametric inference for component lifetime distribution based on lifetime data from systems with known signatures. *Journal of Nonparametric Statistics*, **23**(3) 741–752 (2011).
5. Barlow R.E. and Proschan, F. *Statistical Theory of Reliability and Life Testing*. To Begin With Press (1981).
6. Boland, P.J., Samaniego, F.J. and Vestrup, E.M. Linking Dominations and Signatures in Network Reliability In: *Mathematical and Statistical Methods in Reliability*, World Scientific, NJ, 89-103CRC Press (2003).
7. Brown R.E. *Electric Power Distribution Reliability* (2nd ed.). CRC Press (2008).
8. Coolen F.P.A. and Al-nefaiee A.H. Nonparametric predictive inference for failure times of systems with exchangeable components. *Proceedings of the Institution of Mechanical Engineers, Part O: Journal of Risk and Reliability*, **226** 262–273 (2012).
9. Coolen F.P.A. and Coolen-Maturi T. Generalizing the signature to systems with multiple types of components. In: W. Zamojski *et al* (Eds.), *Complex Systems and Dependability*, Springer, pp. 115–130 (2012).
10. Coolen F.P.A., Coolen-Maturi T. and Al-nefaiee A.H. Nonparametric predictive inference for system reliability using the survival signature. *Proceedings of the Institution of Mechanical Engineers, Part O: Journal of Risk and Reliability*, to appear (2014).
11. Eryilmaz S. Review of recent advances in reliability of consecutive k -out-of- n and related systems. *Proceedings of the Institution of Mechanical Engineers, Part O: Journal of Risk and Reliability*, **224** 225–237 (2010).
12. Flegal J.M. and Jones G.L. Implementing Markov chain Monte Carlo: Estimating with confidence. In: S. Brooks *et al.* (Ed.), *Handbook of Markov Chain Monte Carlo*, pp. 175–197 (2011).
13. Navarro, J., Ng, H.K.T. and Balakrishnan, N. Parametric Inference for Component Distributions from Lifetimes of Systems with Dependent Components. *Naval Research Logistics*, **59** 487–496 (2012).
14. Samaniego F. *System Signatures and their Applications in Engineering Reliability*. Springer (2007).
15. Tierney L. Markov Chains for Exploring Posterior Distributions. *The Annals of Statistics*, **22**(4) 1701–1728 (1994).